

---

ND1405:2007/03

---

**Guidelines on the  
Use of DSL Transmission Systems  
in the BT Access Network**

---

Issue 2

Network Interoperability Consultative Committee  
Ofcom  
Riverside House,  
2a Southwark Bridge Road,  
London SE1 9HA  
UK  
<http://www.nicc.org.uk>

## **Normative Information**

### **© 2007 Ofcom copyright NOTICE OF COPYRIGHT AND LIABILITY**

#### **Copyright**

All right, title and interest in this document are owned by Ofcom and/or the contributors to the document unless otherwise indicated (where copyright be owned or shared with a third party). Such title and interest is protected by United Kingdom copyright laws and international treaty provisions.

The contents of the document are believed to be accurate at the time of publishing, but no representation or warranty is given as to their accuracy, completeness or correctness. You may freely download, copy, store or distribute this document provided it is not modified in any way and it includes this copyright and liability statement.

You may not modify the contents of this document. You may produce a derived copyright work based on this document provided that you clearly indicate that it was created by yourself and that it was derived from this document and provided further that you ensure that any risk of confusion with this document is avoided.

#### **Liability**

Whilst every care has been taken in the preparation and publication of this document, NICC, nor any committee acting on behalf of NICC, nor any member of any of those committees, nor the companies they represent, nor any person contributing to the contents of this document (together the "Generators") accepts liability for any loss, which may arise from reliance on the information contained in this document or any errors or omissions, typographical or otherwise in the contents.

Nothing in this document constitutes advice. Nor does the transmission, downloading or sending of this document create any contractual relationship. In particular no licence is granted under any intellectual property right (including trade and service mark rights) save for the above licence to copy, store and distribute this document and to produce derived copyright works.

The liability and responsibility for implementations based on this document rests with the implementer, and not with any of the Generators. If you implement any of the contents of this document, you agree to indemnify and hold harmless the Generators in any jurisdiction against any claims and legal proceedings alleging that the use of the contents by you or on your behalf infringes any legal right of any of the Generators or any third party.

None of the Generators accepts any liability whatsoever for any direct, indirect or consequential loss or damage arising in any way from any use of or reliance on the contents of this document for any purpose.

If you have any comments concerning the accuracy of the contents of this document, please write to:

The Technical Secretary, Network Interoperability Consultative Committee,  
Ofcom,  
2a Southwark Bridge Road,  
London SE1 9HA.

---

## CONTENTS

<b>NOTICE OF COPYRIGHT AND LIABILITY .....</b>	<b>2</b>
<b>1. FOREWORD .....</b>	<b>4</b>
<b>2. INTRODUCTION .....</b>	<b>4</b>
<b>3. SCOPE.....</b>	<b>4</b>
<b>4. COMPLIANCE WITH THE ANFP .....</b>	<b>4</b>
<b>5. APPLICATION OF THE BT ANFP .....</b>	<b>5</b>
<b>6. GUIDANCE ON THE USE OF DSL IN THE BT ACCESS NETWORK .....</b>	<b>6</b>
6.1 ANALOGUE VOICE-BAND FREQUENCY SYSTEMS.....	6
6.2 ISDN BASIC ACCESS .....	7
6.2.1 2B1Q Linecode .....	7
6.2.2 MMS43/4B3T Linecode .....	8
6.3 HDSL.....	8
6.4 SHDSL .....	9
6.5 ENHANCED SHDSL (SHDSL.BIS).....	13
6.6 ADSL AND ADSL2.....	17
6.6.1 ADSL/ADSL2 compliance to the ANFP.....	17
6.6.1.1 Part A: MDF requirements and Part D: MDF EO requirements.....	17
6.6.1.2 Part B: Cabinet requirements .....	19
6.6.1.3 Part C: Customer end requirements.....	20
6.7 READSL2 (ANNEX L).....	25
6.8 EXTENDED UPSTREAM ADSL (ANNEX M) .....	25
6.9 ADSL2 PLUS .....	25
6.9.1 ADSL2+ Compliance with ANFP.....	26
6.9.1.1 Part A: MDF Requirements and Part D: MDF EO Requirements .....	26
6.9.1.2 Part B: Cabinet Requirements .....	26
6.9.1.3 Part C: Customer End Requirements.....	27
6.10 VDSL.....	28
6.10.1 VDSL Compliance with ANFP.....	29
6.11 VDSL2.....	29
6.12 ETHERNET IN FIRST MILE.....	30
<b>7. ABBREVIATIONS.....</b>	<b>30</b>
<b>8. REFERENCES .....</b>	<b>31</b>
<b>9. HISTORY.....</b>	<b>31</b>

## 1. Foreword

This document has been produced by the NICC Task Group on Digital Subscriber Line (DSL). Representatives from network operators, switch and terminal equipment manufacturers, test laboratories, DTI, and Ofcom participated in the Task Group.

This document includes reference to and extracts from White Papers published by the DSL Forum (at [http://www.dslforum.org/aboutdsl/whitepaper\\_index.html](http://www.dslforum.org/aboutdsl/whitepaper_index.html)). The DSL Task Group wishes to acknowledge and express its appreciation to the DSL Forum for permission to include these references and extracts.

## 2. Introduction

As part of the Local Loop Unbundling (LLU) project in the UK, the NICC DSL Task Group developed Access Network Frequency Plans (ANFP) for both the BT [1] and KCH [3] networks. These ANFP specifications were necessary in order to manage crosstalk interference, particularly between xDSL systems, operating over a public access network in the multi-operator environment resulting from LLU.

Compliance with the relevant ANFP is a necessary requirement for all users of the access network, in order to ensure crosstalk interference is controlled. Hence the ANFP determines what xDSL systems can be connected at agreed connections points in the access network and in what configuration.

This document provides guidance on the implementation of xDSL system to ensure compliance with the relevant part of the ANFP. Whilst every effort has been taken to ensure the accuracy of this document, in the event of an inconsistency with the relevant ANFP, the ANFP is the normative text. ***In particular, the obligation on users of the access network is to comply with the relevant ANFP, not with this document.***

This document is an updated issue of ND1405:2005/08 to take account of the updating of the BT ANFP to Issue 4 [1]. This update of the BT ANFP is fully backward compatible with the previous version [2] ie xDSL systems that were compliant under the previous issue of the BT ANFP [2] remain compliant under this new issue [1]. However, some xDSL systems that were not complaint under the previous issue (eg enhanced SHDSL –see section 6.5) are compliant in some configurations under the new ANFP [1].

## 3. Scope

The scope of this guideline is restricted to covering the use of xDSL systems designed to international standards on the BT access network, configured and operated to comply with the currently (i.e. at the date of publication of this document) defined BT ANFP [1].

It is recognised that xDSL technology and their related international standards continue to be developed. Equally, there maybe further discussion in the NICC DSL Task Group on potential amendments to the BT ANFP. This document may be updated to take account of new, internationally standardised xDSL systems and/or revision to the BT ANFP.

Note: This document only considers transmission systems operating over the BT access network. When private networks are connected to the BT access network, signals from the private network transmitted on to the BT access network need to comply with the ANFP. A separate document [6] discusses and gives guidance on this issue.

## 4. Compliance with the ANFP

BT ANFP [1] Section 3 (ANFP Conformance and Interference Management) describes the requirements and process for ensuring ANFP compliance. In particular, it should be noted that all equipment connected to the BT access network (i.e. BT equipment, LLU Operator equipment and CPE) needs to comply with the ANFP.

Demonstration of compliance is via a system of self-declaration. A test specification is defined in the ANFP (Sections 2.2.2 and 4 of the ANFP [1]) to allow verification of compliance. It is the responsibility of the organisation implementing and operating the equipment to ensure and maintain its compliance to the ANFP.

### 5. Application of the BT ANFP

The BT ANFP [1] defines the requirements in terms of specifying the location points in the access network where transmission equipment can be connected and the maximum transmit power that can be injected at those points. This maximum transmit power is defined by a PSD (power spectrum density) mask.

Figure 1 (taken from the BT ANFP) shows the points in the BT access at which the ANFP applies. The equipment configurations illustrate dedicated (i.e. not shared) and shared, full loop Metallic Path Facility (MPF) and sub-loop scenarios. The location of equipment (i.e. modems and splitters) at the Main Distribution Frame (MDF) site and near the Sub Loop Connection Point (SLCP), and the wiring arrangements for the splitter filters, are illustrative only and do not necessarily represent actual implementation.

The ANFP applies to the signal levels at the actual point of connection to the BT metallic access network i.e. at the MDF, Sub-loop Distribution Frame (SDF) or Network Termination Point (NTP).

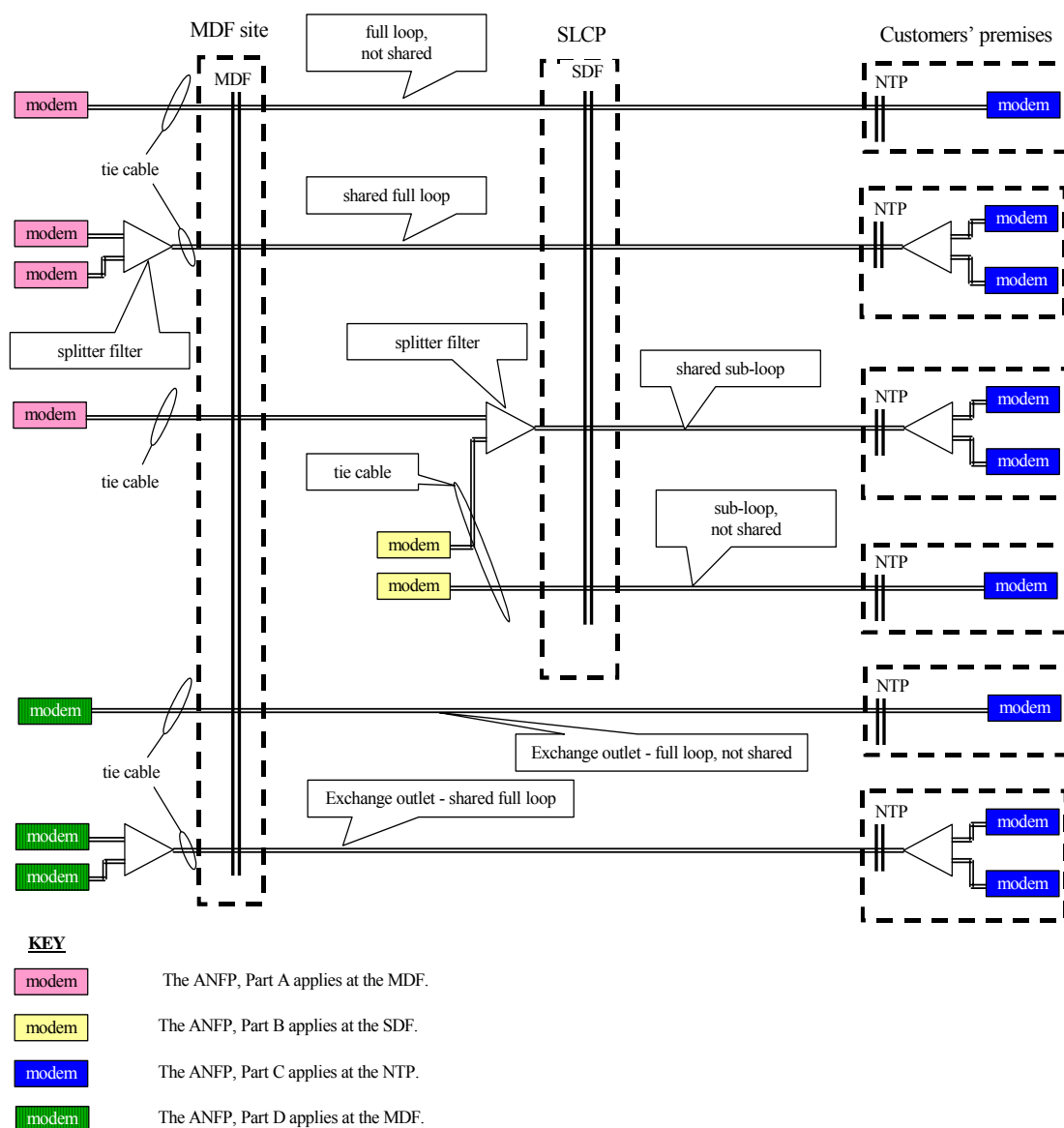

**Figure 1 – Application of the ANFP**

For each point of application of the ANFP defined in Figure 1, a PSD mask (or set of PSD masks) is defined. Table 1 lists the 4 points of ANFP application and shows where in the ANFP specification the PSD mask(s) is specified.

Point of Application of the ANFP	Location in ANFP [1] for PSD Mask specification
MDF (at an MDF site/exchange) connected to metallic access network cables routed to an NTP via a SLCP.	Part A
SDF (at a sub-loop connection point)	Part B
NTP (at the customers premises)	Part C
MDF Exchange Outlet (at an MDF site/exchange) connected to metallic access network cables routed directly to an NTP without a SLCP included in the routing and not sharing a cable sheath containing cables routed via a SLCP.	Part D

**Table 1 - Interface Categories and PSD Mask Specification**

When considering compliance of access transmission equipment to the ANFP, the proposed connection point (MDF, SDF, NTP) needs to be considered and in the case of connection at the SDF and NTP, the SLCP CAL (Cabinet Assigned Loss) and ANFP line category respectively.

## 6. Guidance on the use of DSL in the BT Access Network

This section describes the various standardised access transmission systems currently available or being developed and considers whether they comply with the BT ANFP.

*Note: xDSL systems that are non-compliant with the BT ANFP are highlighted and the details of their non-compliance described. It should be noted that there are mechanisms defined in the international standards to use the xDSL associated management system to permit the network operator to reduce or shape the transmit PSD of a system. This can be used to make an ANFP non-compliant system compliant.*

The ANFP does not exclude specific systems; it excludes by implication: one may not install a system that does not conform to the appropriate masks at each of its ends. For example the ANFP would exclude the following standardised systems<sup>1</sup> from use on *any* BT access network line ('ultra short', 'extra short', 'short', 'medium' or 'long'):

- ISDN basic access using MMS43/4B3T linecode - see Section 6.2.2.
- A 1-pair 2.3 Mbit/s HDSL system using 2B1Q or CAP
- ADSL over ISDN
- Reverse ADSL (i.e. with the high bandwidth implemented in the customer to exchange direction). This means that ADSL is precluded from use on private circuits.
- VDSL deployed at an MDF site.

### 6.1 Analogue Voice-band Frequency Systems

These systems comply with all Parts of the ANFP [1] and hence may be connected at all defined connections points to the BT access network.

<sup>1</sup> This list is of course not exhaustive.

## 6.2 ISDN Basic Access

### 6.2.1 2B1Q Linecode

Basic-rate access transmission for the Integrated Services Digital Network (ISDN-BA) uses a 4-level Pulse Amplitude Modulation (PAM) linecode known as 2B1Q. ISDN transceivers used in the UK employ Echo Cancellation techniques to enable full duplex transmission at 160kbit/s on a single unloaded telephony wire pair. The peak power spectral density of 2B1Q-based DSL systems is around 40kHz with the first spectral null at 80kHz. ITU-T Recommendation G.961 and ETSI TS 102 080 V1.4.1 (2003-07) are the relevant international standards.

The ISDN payload is usually 2 x 'B' or Bearer channels at 64kbit/s each plus a 'D' or signalling channel at 16kbit/s. This gives the user access to 128kbit/s plus signalling (144kbit/s). An extra overhead of 16kbit/s is provided for an Embedded Operations Channel (EOC), intended for exchanging information between the LT (Line Terminal) and NT (e.g. link performance statistics). The EOC is not normally accessible to the user.

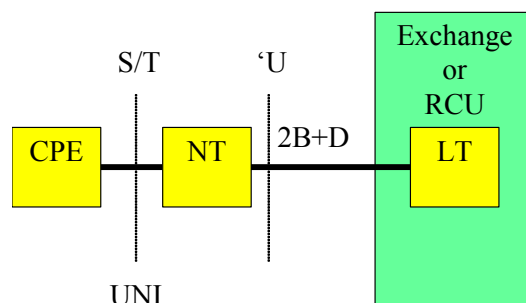

Figure 2 - Basic-rate ISDN-BA concept (DSL)

It is worth mentioning that DSL technology is also used as the transmission bearer technology for Digital Access Carrier (DAC) systems, which is used by BT to provide expedient 'analogue pair gain'. Pair gain systems convert a single wire-pair into two fully independent voice-band circuits and are used to provide normal analogue telephony service where there are insufficient copper pairs for a single metallic path per customer. Such systems are often used as expedient ways of providing service whilst more copper pairs are installed or to make maximum use of the existing infrastructure, obviating the need for more investment in providing D- or E-side pairs<sup>2</sup>.

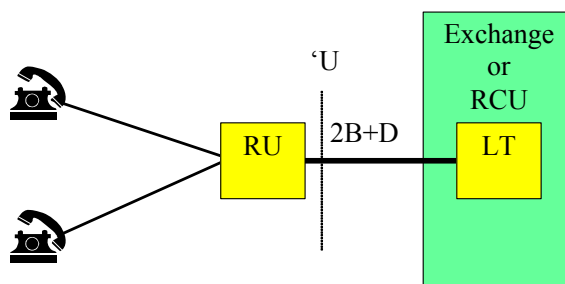

Figure 3 - Two channel digital pair gain (DACs) using ISDN-BA

**2B1Q linecode ISDN basic access systems are compliant to all parts of the ANFP [1]**

<sup>2</sup> D and E-side pair refer to a metallic pair between the SDF and NTP and between the MDF and SDF respectively.

### 6.2.2 MMS43/4B3T Linecode

There is a second type of ISDN system used in some parts of Europe (predominantly Germany) that uses an alternative line code called MMS43 or 4B3T. This system is defined in Annex B of ETSI TS 102 080 V1.3.2 (2000-05). In section B.12.4 of that document the PSD requirements are defined.

These requirements have been plotted in Figure 4 as the black graph, against the NTP-end requirements of the ANFP. It can be seen that a *system that is only just compliant with the standard violates the ANFP for all loop categories and therefore cannot be used on the BT access network.*

However it is noted that the requirements of the standard are loose; for example the penultimate paragraph of B.12.4.1 states "The result shall be less -120 dBm/Hz or at least more than 7 dB below the PSD...". This strongly suggests that it may be possible to procure MMS43-based ISDN systems with a vendor warranty of compliance to some or all categories of the ANFP.

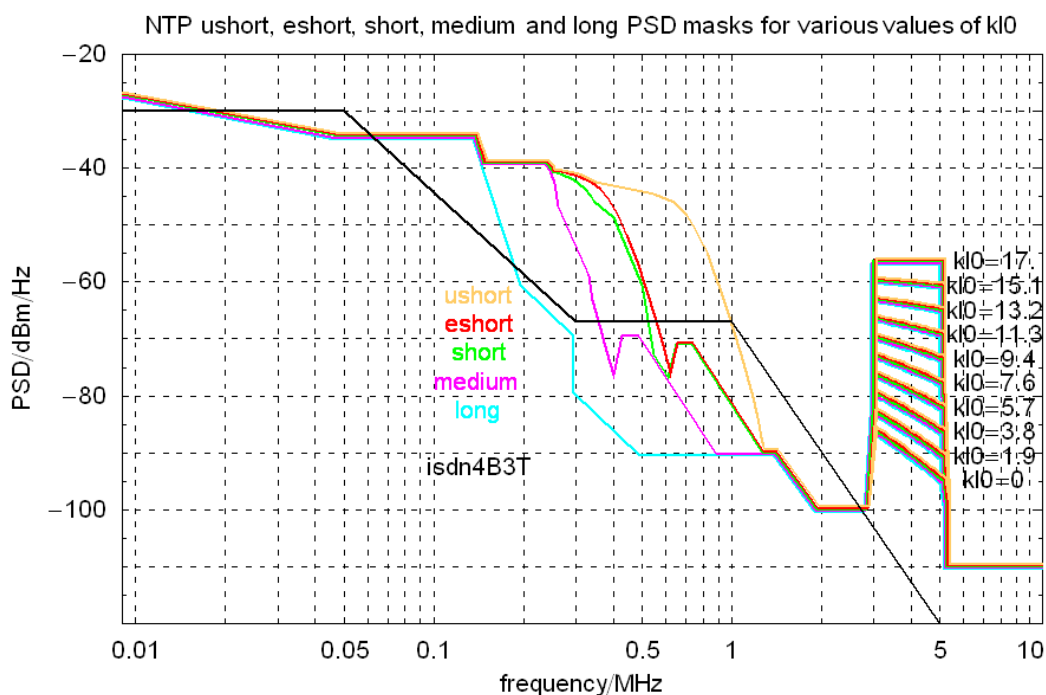

Figure 4 - MMS43/4B3T ISDN-BA versus ANFP Part D (NTP) PSD masks

### 6.3 HDSL

High bit-rate DSL modem standards evolved from earlier work on ISDN-BA. HDSL is a bi-directional symmetric transmission system that allows the transport of signals with a bit-rate of 1.544Mbit/s or 2.048Mbit/s on access network wire-pairs. HDSL uses the echo cancellation technique for the separation of the different directions of transmission. Two different options for the linecode are available; Pulse Amplitude Modulation 2B1Q and the Carrierless Amplitude Modulation (CAP).

The 2B1Q HDSL system for 2.048Mbit/s caters for both duplex transmission on a single pair and parallel transmission on two or three pairs. This allows for the distribution of the data to several pairs and for the reduction of the symbol rate to increase the line length or transmission reach. CAP is defined for one or two pairs only and the 1.544Mbit/s 2B1Q for two pairs only. DSL bandwidth therefore increased (compared to ISDN-BA) to around 4-500kHz with the advent of HDSL.



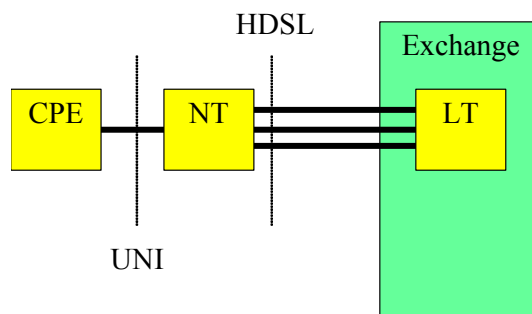

**Figure 5 - High bit-rate DSL concept (HDSL)**

ANSI T1E1.4 standardised HDSL in order to deliver 1.544Mbit/s (DS1) digital access using two wire-pairs, each carrying 784kbit/s. A framer/deframer was specified in order to separate the incoming data into two streams and recombine them at the receiver. This type of system has been very successful in North America.

In Europe, ETSI built on the good foundation work and initially adopted and standardised the 2B1Q 784kbit/s HDSL for providing structured and unstructured 2.048Mbit/s access using three wire-pairs. Subsequently, with improvements in HDSL technology, a 2-pair variant was standardised by ETSI followed by a 1-pair variant, each delivering 2.048Mbit/s over progressively shorter loops. ETSI also specified a Carrierless Amplitude/Phase variant for operation over one and two wire-pairs. This is in contrast to ANSI who only standardised the use of the 2B1Q linecode for 2-pair HDSL delivering 1.544Mbit/s.

It is worth noting that ETSI has also specified HDSL for use in SDH applications where VC-12 or TU-12 can be transported in a 2.3 Mbit/s payload. However, there are spectral compatibility problems (interference to ADSL) with single pair HDSL systems running at such high bit-rates, which preclude their use on the BT network. This is because the Near end Crosstalk (NEXT) from single pair HDSL is very damaging to a Far end Crosstalk (FEXT) limited ADSL system.

The ITU-T also endorsed the use of HDSL via the G.991.1 standard. This Recommendation merges both the ANSI (TR No. 28) and ETSI TS 101 135 V1.5.3 (2000-09) specifications into a single standard.

The standardised HDSL systems listed in Table 2 are compliant with the ANFP.

ANFP Part C		
Ultra Short, Extra Short and Short Lines	Medium Line	Long Line
HDSL (2 pair E1) – 2B1Q	HDSL (3 pair E1) – 2B1Q	
HDSL (2 pair E1 - 1168 kbit/s) - CAP	HDSL (2 Pair E1 - 1168 kbit/s) - CAP	

**Table 2 - HDSL systems allowed under the ANFP**

#### 6.4 SHDSL<sup>3</sup>

The ITU-T SG 15/4 completed work on G.SHDSL (G.991.2-2001) in 2001. The ITU standard for Single-pair High-speed Digital Subscriber Line (SHDSL) Transceivers Recommendation G.991.2 describes a symmetric transmission method for data transport in access networks. SHDSL is designed to transport rate-adaptive symmetrical data across a single copper pair at data rates from 192 kbps to 2.3 Mbps or 384 kbps to 4.6 Mbps over two pairs. Using a Trellis Coded Pulse Amplitude Modulation (TC-PAM) line code G.991.2 modems can be configured to operate at longer ranges than most of the

<sup>3</sup> SHDSL is often referred to as SDSL (Symmetric DSL). This should not be confused with the USA use of the term 'SDSL' which refers to DSL systems similar to HDSL.

existing DSL technologies, while maintaining spectral compatibility with all other DSL technologies when regional spectral deployment guidelines are followed. Table 3 lists the maximum G.SHDSL rates that are compliant to the ANFP. The downstream PSD for the fastest G.SHDSL speed versus the ANFP exchange mask is show in Figure 6.

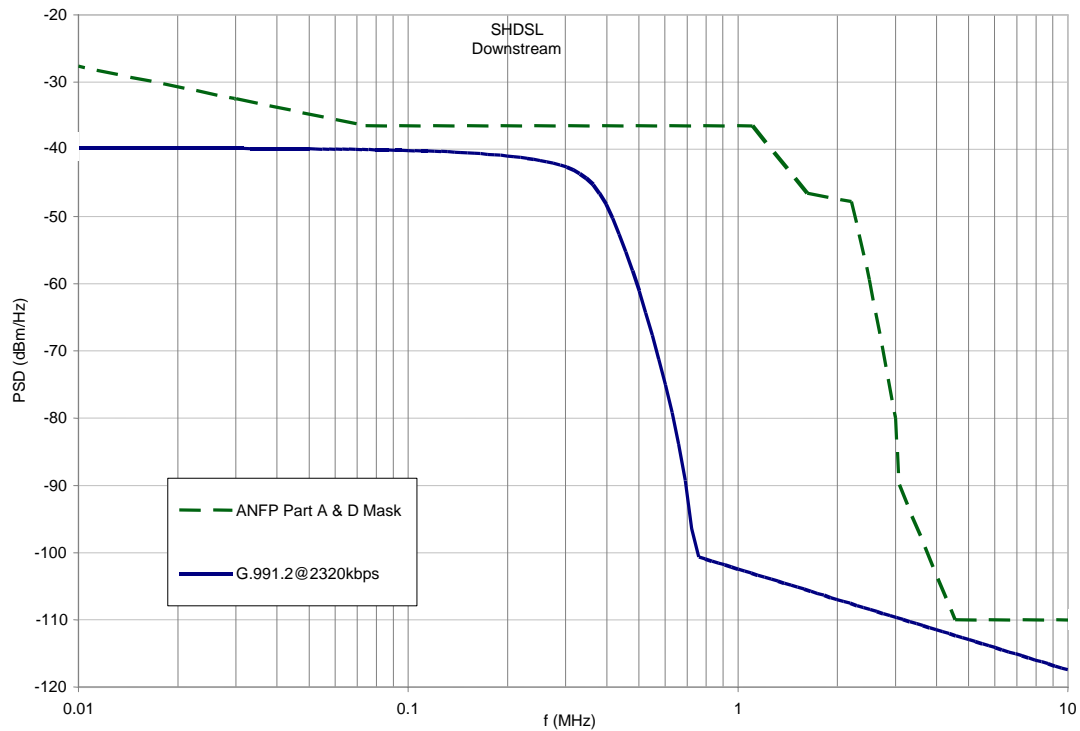

**Figure 6 - G.991.2 running at 2320kbps versus ANFP Part A and Part D PSD Masks**

ANFP Loop Category (nominal electrical length)	Maximum SHDSL Line Rate <sup>4</sup>
Ultra Short (typically $\leq 11$ dB)	2320 kbps
Extra Short (typically $> 11$ dB, $\leq 21$ dB)	2320 kbps
Short (typically $> 21$ dB, $\leq 26$ dB)	2056 kbps
Medium (typically $> 26$ dB, $\leq 29$ dB)	1505 kbps
Long (typically $> 29$ dB)	784 kbps

**Table 3 - Maximum SHDSL line rates allowed under the ANFP**

Figure 7 to Figure 10 below show the compliant G.SHDSL PSD masks for the different ANFP loop categories.

<sup>4</sup> The line rate includes the 8 kbps overhead for framing and signalling. Hence the equivalent user rate is 8 kbps less.

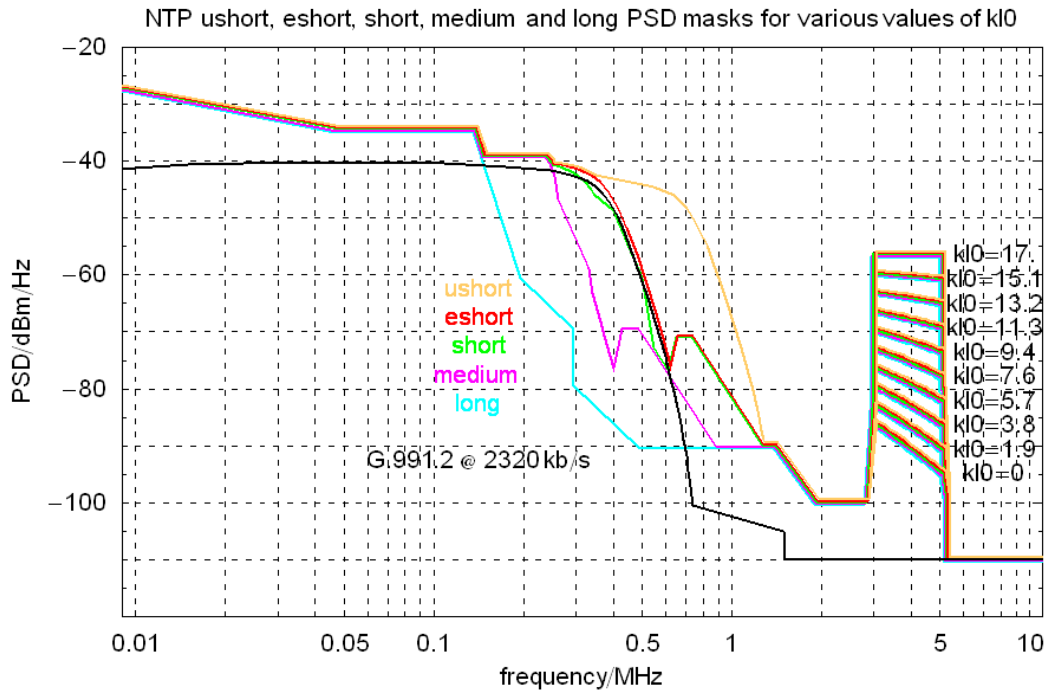

Figure 7 - G.991.2 running at 2320kbps versus ANFP Part C (All Mask)

Figure 7 shows that SHDSL running at 2320 kbps is only compliant on Ultra Short and Extra Short lines.

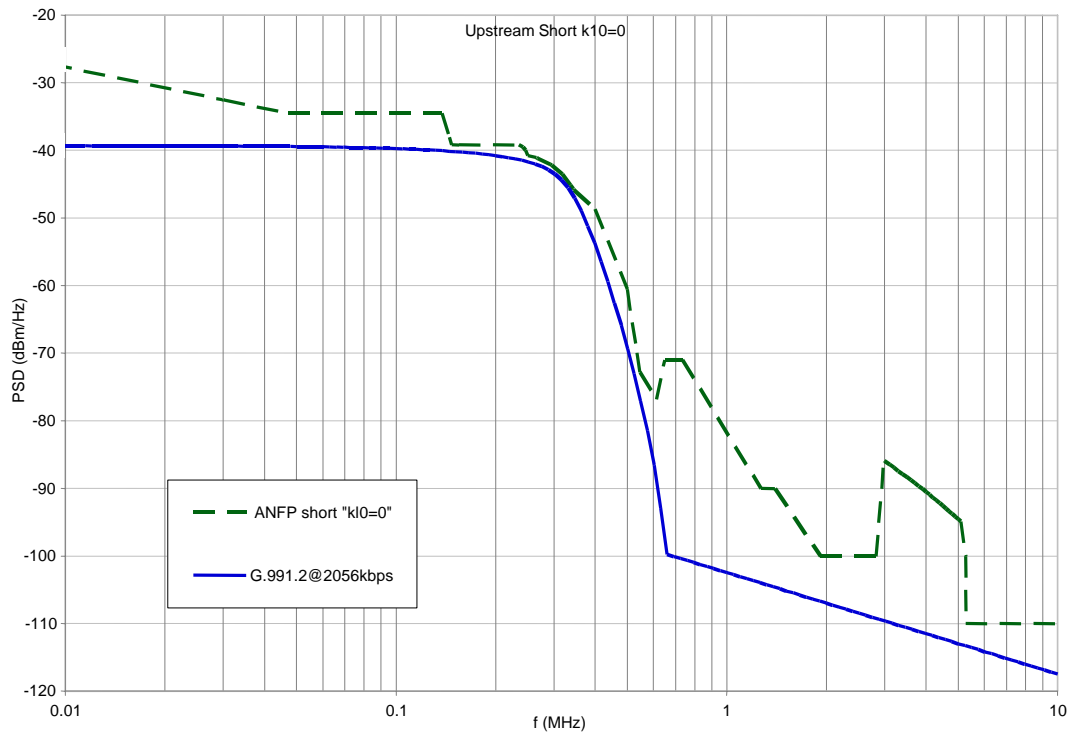

Figure 8 - G.991.2 running at 2056kbps versus ANFP Part C (Upstream Short mask)

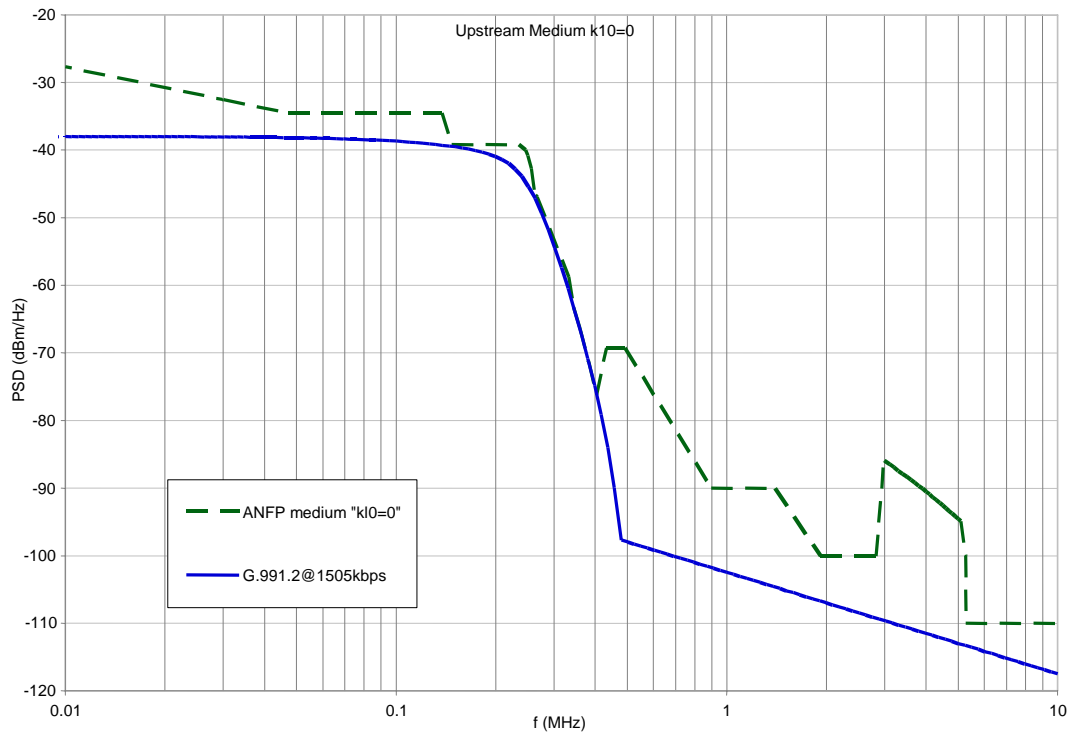

Figure 9 - G.991.2 running at 1505kbps versus ANFP Part C (Upstream Medium mask)

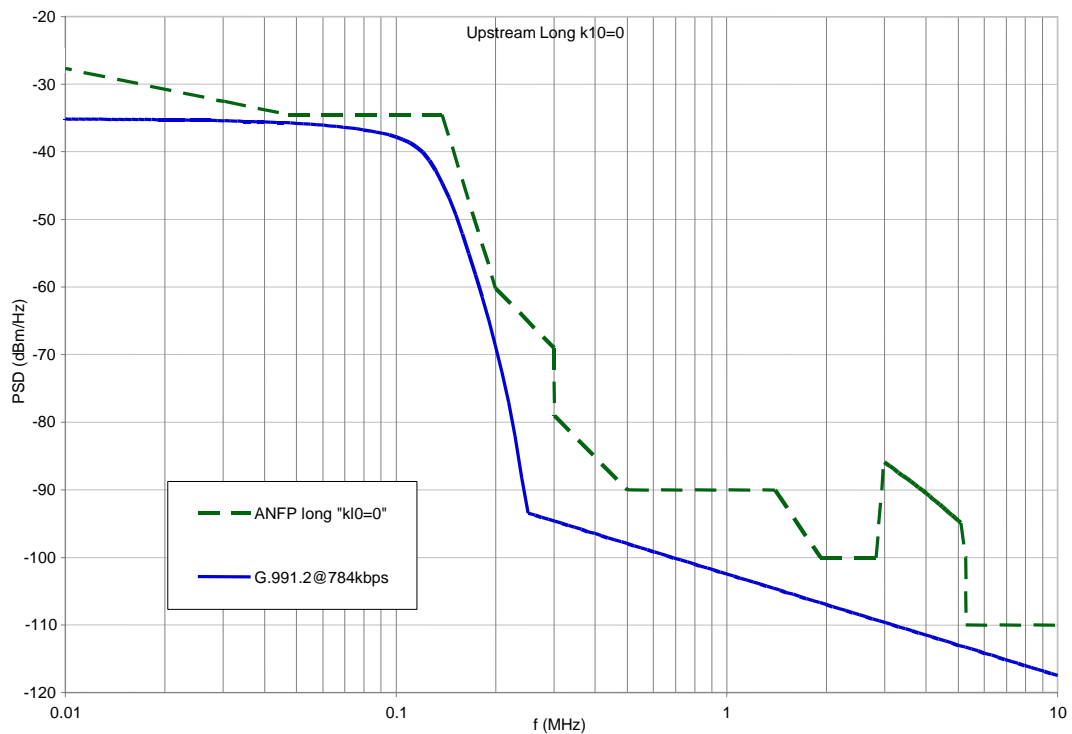

Figure 10 - G.991.2 running at 784kbps versus ANFP Part C (Upstream Long mask)

### 6.5 Enhanced SHDSL (SHDSL.bis)

An enhanced version of SHDSL commonly referred to as G.SHDSL.bis (G.991.2-2003), was released in 2003. Optional extensions which are more spectrally dense by a factor of 4/3 than the non-enhanced version support rates up to 5696 kbit/s are described in Annex F and Annex G<sup>5</sup>. Annex F describes the extensions for region 1 (North America) whilst Annex G describes the extensions for region 2 (Europe). Since SHDSL.bis has a symmetrical PSD, the limiting masks are the upstream ones, these being more restrictive than the downstream mask (as far as SHDSL is concerned). Figure 11 shows the maximum SHDSL.bis rate PSD compared to the ANFP downstream mask. It is also worth mentioning that the EFM (Ethernet in the First Mile) standard (IEEE 802.3ah) uses SHDSL.bis line coding for the long reach PHY (EFMC LR) - see also Section 6.12.

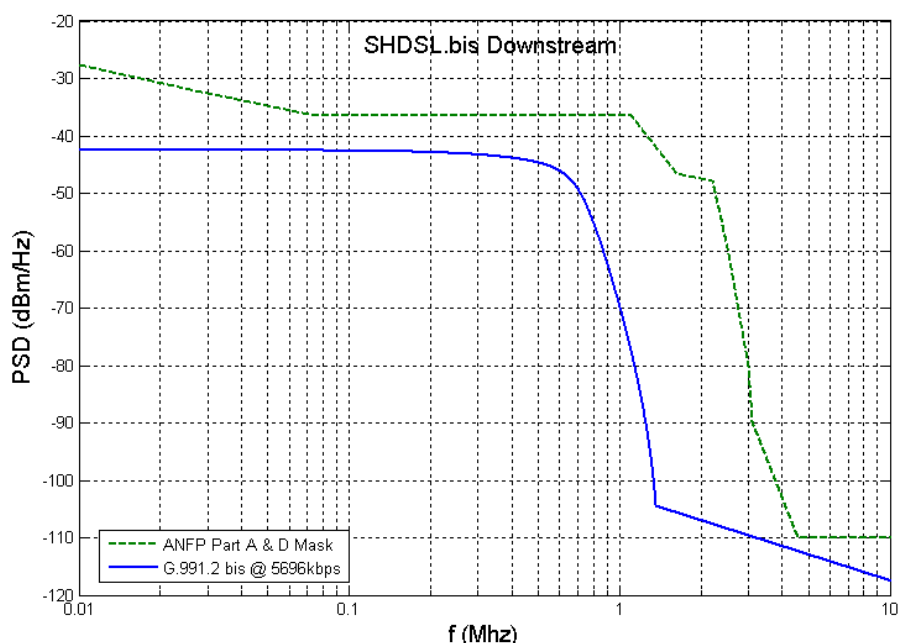

Figure 11 - G.991.2.bis running at 5696kbps versus ANFP Part A and Part D PSD Masks

ANFP Loop Category (nominal electrical length)	Maximum SHDSL.bis Line Rate for TCPAM-16	Maximum SHDSL.bis Line Rate for TCPAM-32 <sup>6</sup>
Ultra Short (typically $\leq 11$ dB)	3840 kbps <sup>7</sup>	5696 kbps
Extra Short (typically $> 11$ dB, $\leq 21$ dB)	2320 kbps <sup>8</sup>	3088 kbps
Short (typically $> 21$ dB, $\leq 26$ dB)	2056 kbps	2736 kbps
Medium (typically $> 26$ dB, $\leq 29$ dB)	1504 kbps	2000 kbps
Long (typically $> 29$ dB)	784 kbps	1040 kbps

Table 4 - Maximum SHDSL.bis line rates allowed under the ANFP

<sup>5</sup> Annex G was introduced in G.991.2 amendment 2 (02/2005). ETSI defined a similar Annex E in TS 101 524 rev 1.3.1 (02/2005).

<sup>6</sup> The maximum SHDSL.bis allowed line rate with TC-PAM 32 line code. The line rate includes the 8 kbps overhead for framing and signalling. Hence the equivalent user rate is 8 kbps less.

<sup>7</sup> This rate does not fully exploit the PSD permitted by the Ultra Short category, but is the maximum rate for this constellation described in the eSHDSL Annex of the standard.

<sup>8</sup> The greyed out rates do not need eSHDSL to achieve them, as they can be reached by conventional SHDSL.

Table 4 lists the maximum line rates (this includes the 8 kbps overhead for framing and signalling and hence the user rates are 8 kbps lower) that are allowed for each loop category under the ANFP. Note that these are maximums and there is no guarantee that these rates will be achieved on the different loop categories. Figure 12 to Figure 16 below show the SHDSL.bis PSD masks for the loop categories Ultra Short, Extra Short, Short, Medium and Long respectively.

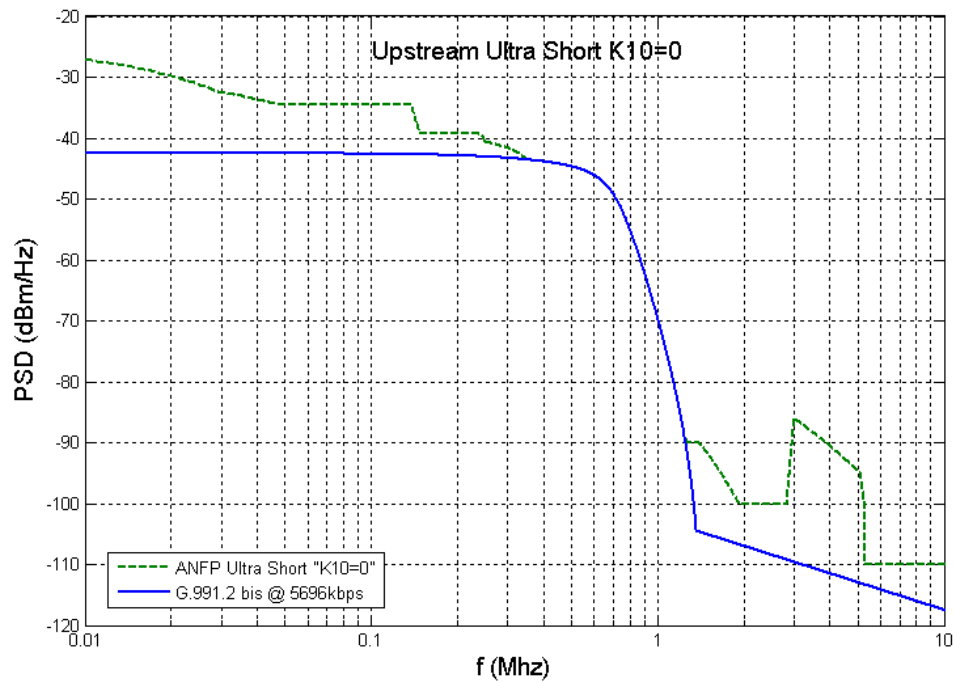

**Figure 12** - G.991.2.bis at 5696 kbps versus ANFP Part C Upstream Ultra Short Mask (k10=0)

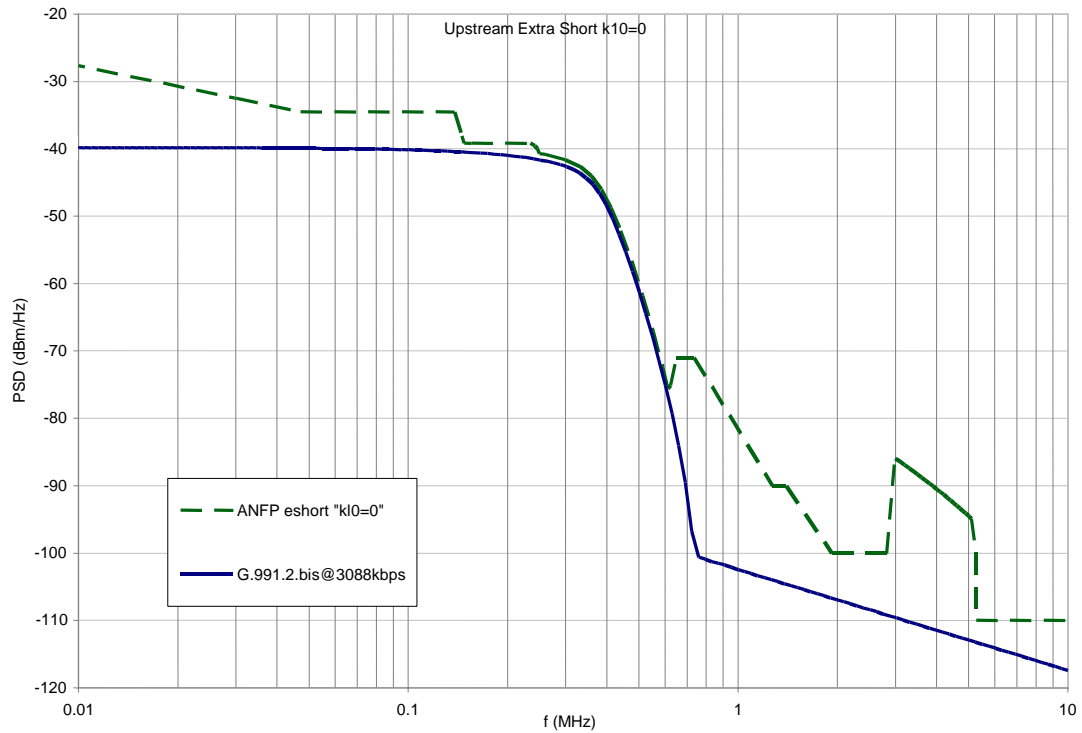

Figure 13 - G.991.2.bis at 3088kbps versus ANFP Part C Upstream Extra Short Mask (k10=0)

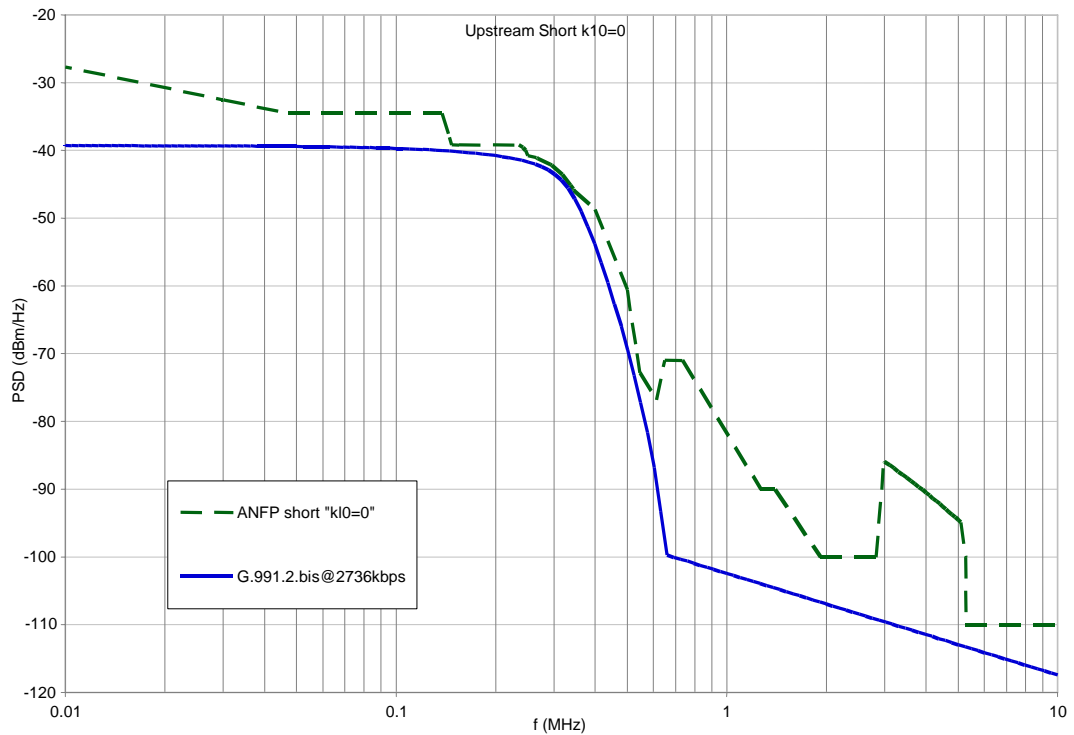

Figure 14 - G.991.2.bis at 2736kbps versus ANFP Part C Upstream Short Mask (k10=0)

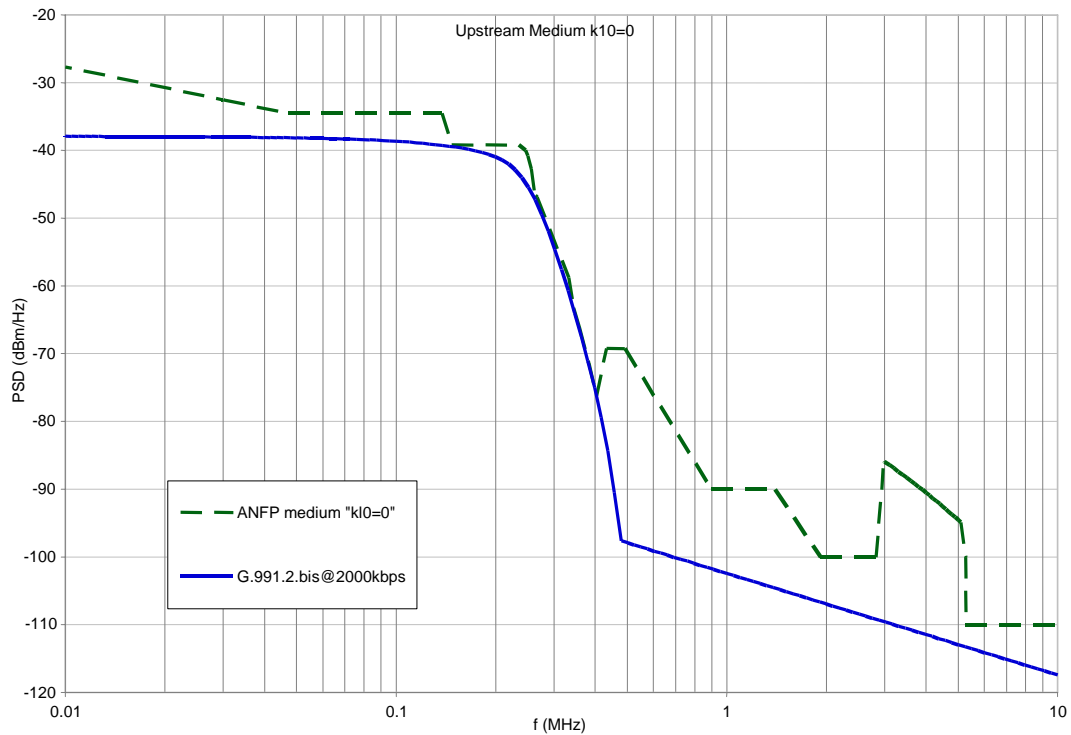

Figure 15 - G.991.2.bis at 2000kbps versus ANFP Part C Upstream Medium Mask (k10=0)

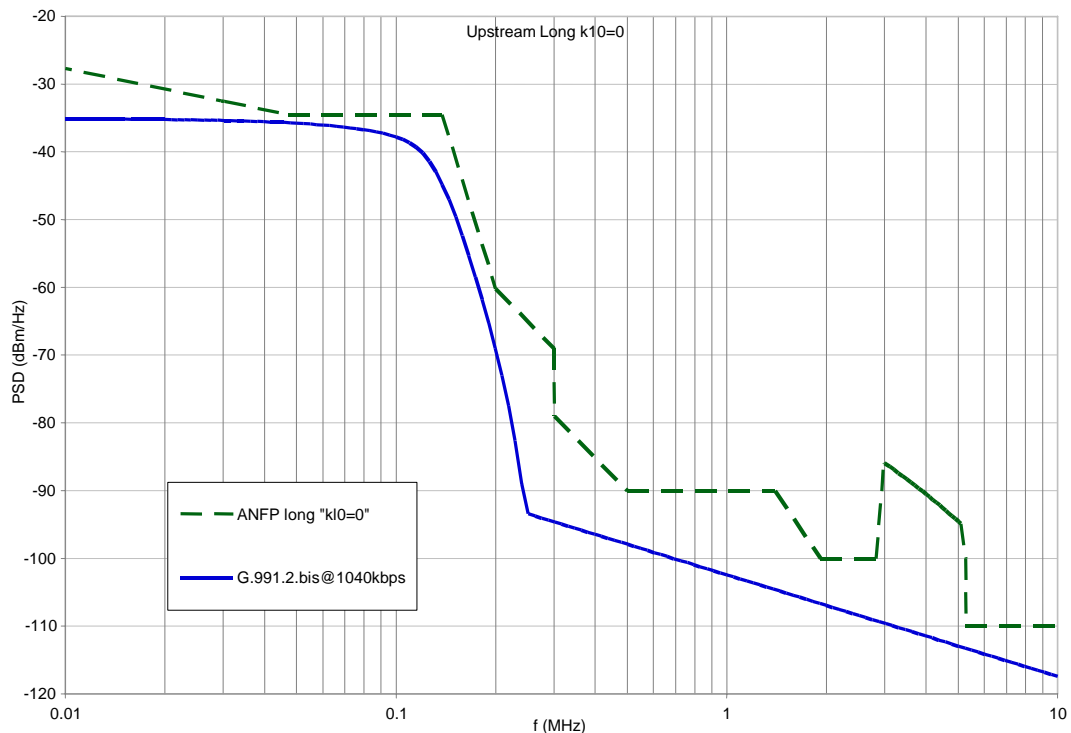

Figure 16 - G.991.2.bis at 1040kbps versus ANFP Part C Upstream Long Mask (k10=0)



## 6.6 ADSL and ADSL2

ITU-T Recommendation G.992.1 (G.dmt) and G.992.2 specify full-rate and splitterless ADSL respectively. These standards include Annexes that define the use of ADSL in various environments throughout the world (see Table 5). Since these two standards were ratified in 1999, the ITU-T has added enhancements to produce the ADSL2 recommendations G.992.3 and G.992.4 (for full-rate and splitterless respectively). The enhancements included in ADSL2 are described in DSL Forum White Paper [4] but both ADSL and ADSL2 use the same frequency spectrum and their compliance with the ANFP can be considered together. The ITU standards incorporate ETSI TS 101 388 V1.3.1 (2002-05).

ADSL2plus (or ADSL2+) is defined in ITU-T Recommendation G.992.5 published in 2003. It uses a frequency spectrum up to 2.2 MHz compared with 1.1 MHz for ADSL/ADSL2 and hence its compliance with the ANFP needs to be considered separately from ADSL/ADSL2 - see Section 6.9.

ADSL standards include Annexes that specify ADSL operation for particular applications and regions around the world. Generally, the Annexes specify subcarriers (or tones) and their associated transmission power levels used for upstream and downstream transmission. The naming convention is such that Annexes to the DMT-based ITU-T DSL standards use the same identifying letter (e.g. A, B, C, etc.) across each of the recommendations to designate the same area of concern and similar use of the DMT subcarriers.

### Use of Tones

Annex	1-5	6-31	32-64	65-255	256-512*	ADSL G.992.1	ADSL2 G.992.3	ADSL2+ G.992.5
A	POTS	UP	DOWN	DOWN	DOWN	YES	YES	YES
B	ISDN	ISDN	UP	DOWN	DOWN	YES	YES	YES
C	TCM ISDN	UP	DOWN	DOWN	DOWN	YES	YES	YES
I	UP	UP	DOWN	DOWN	DOWN	N/A	YES	YES
J	UP	UP	UP	DOWN	DOWN	N/A	YES	YES
L	POTS	UP**	DOWN**	DOWN	DOWN	N/A	YES	NO
M	POTS	UP	UP	DOWN	DOWN	N/A	YES	YES

**Use of tones applies to the non-overlapped PSD masks only**

\* **ADSL2+ only**

\*\* **Not all tones are used**

N/A **Not Applicable**

**Table 5 - ADSL Standard Annexes**

### 6.6.1 ADSL/ADSL2 compliance to the ANFP

Parts A, B, C and D given in the sub-section headings below, refer to the respective Part of the ANFP [1].

#### 6.6.1.1 Part A: MDF requirements and Part D: MDF EO requirements

Table 6 is a summary of the compliance of ADSL and ADSL2 equipment with the ANFP Part A and Part D, where tones shown in *red* indicate non-compliance.

Annex	1-5	6-31	32-64	65-255
A	POTS		DOWN	DOWN
B	ISDN	ISDN		DOWN
C	<i>TCM</i> <i>ISDN</i>		DOWN	DOWN
I			DOWN	DOWN
J				DOWN
L	POTS		<i>DOWN</i>	DOWN
M	POTS			DOWN

**Table 6 -ADSL2 v ANFP Parts A and D**

The cases where tones used are not supported by ANFP are demonstrated in Figure 17 below.

**Annex L**

The ATU-C downstream transmit spectral mask for Annex L is not supported by the ANFP without downstream spectrum shaping. See Figure 17 and also Section 6.7. (The figure uses the values from ITU-T G.992.3 section L.1.3 "ATU-C downstream transmit spectral mask for non-overlapped spectrum reach-extended operation".)

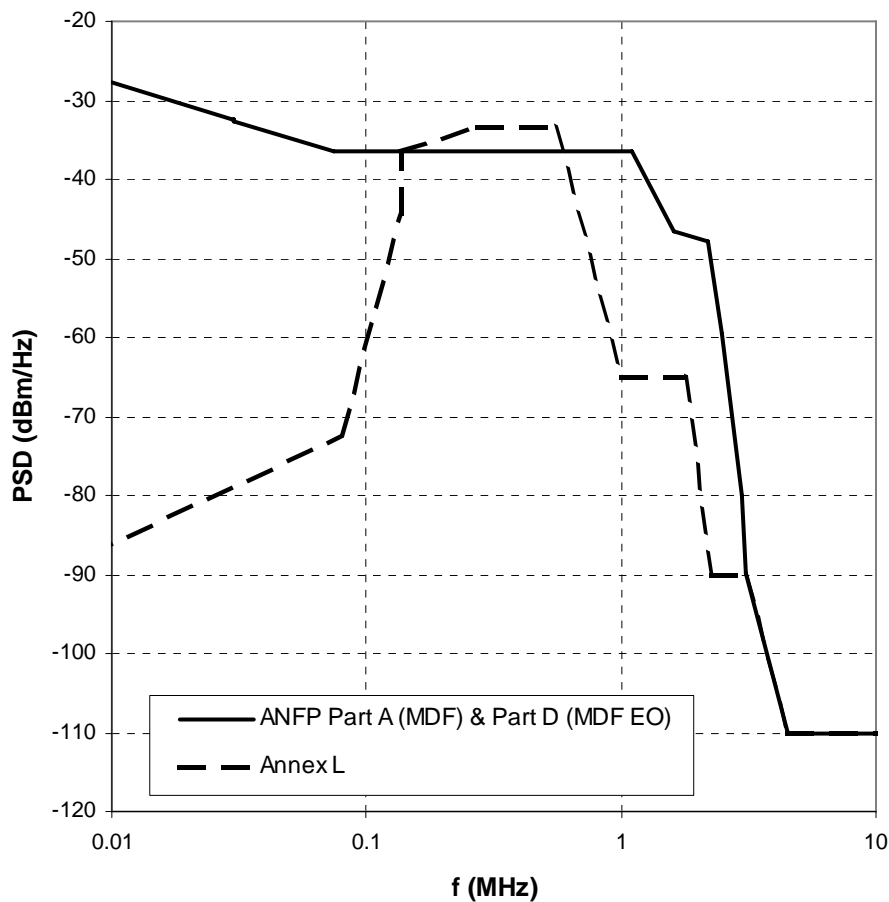

**Figure 17 - ANFP Parts A and D PSD mask and ADSL2 Annex L downstream peak PSD mask.**

6.6.1.2 Part B: Cabinet requirements

Table 7 is a summary of the compliance of ADSL and ADSL2 equipment with the ANFP Part B, where tones shown in red indicate non-compliance.

Annex	1-5	6-31	32-64	65-255
A	POTS		DOWN	DOWN
B	ISDN	ISDN		DOWN
C	TCM ISDN		DOWN	DOWN
I			DOWN	DOWN
J				DOWN
L	POTS		DOWN	DOWN
M	POTS			DOWN

Table 7 - ADSL2 v ANFP Part B

The cases where tones used are not supported by ANFP are demonstrated in Figure 18 below.

The ATU-C downstream transmit spectral mask for all Annex (A, B, I, J, L, and M) is not supported by the ANFP without downstream spectrum shaping. See Figure 18. (The figure uses the values from ITU-T G.992.3 section A.1.3 "ATU-C transmitter PSD mask for non-overlapped spectrum operation".)

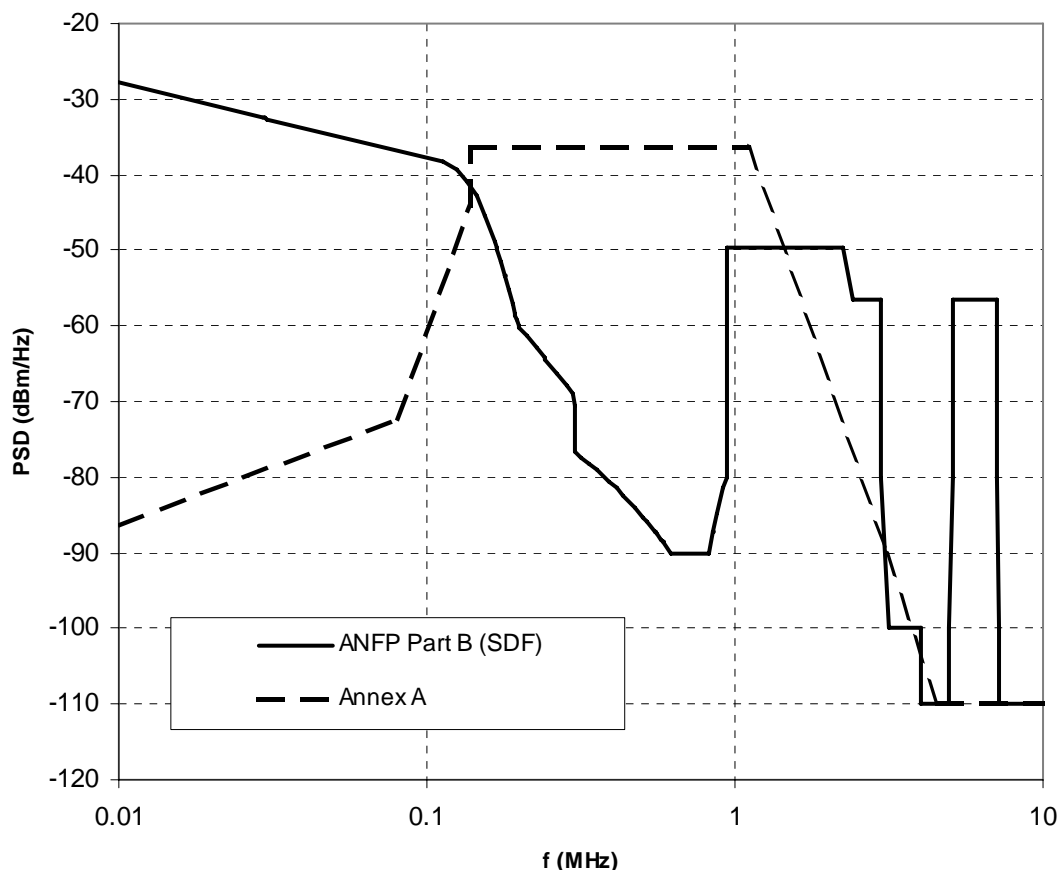

Figure 18 - ANFP Part B PSD mask with CAL = 40 and ADSL2 Annex A downstream peak PSD mask.

6.6.1.3 Part C: Customer end requirements

Table 8 is a summary of the compliance of ADSL and ADSL2 equipment with the ANFP Part C, where tones shown in red indicate non-compliance.

Annex	1-5	6-31	32-64	65-255
A	POTS	UP		
B	ISDN	ISDN	UP	
C	TCM ISDN	UP		
I	UP	UP		
J	UP	UP	UP	
L	POTS	UP**		
M	POTS	UP	UP	

Table 8 - ADSL2 v ANFP Part C

The cases where tones used are not supported by ANFP are demonstrated in Figure 19 to Figure 23 below.

Annex B

The ATU-R upstream transmit spectral mask for Annex B is not supported by the ANFP without upstream spectrum shaping.

Example shown in Figure 19. (The figure uses the values from ITU-T G.992.3 section B.2.2 “ATU R upstream transmit spectral mask”.)

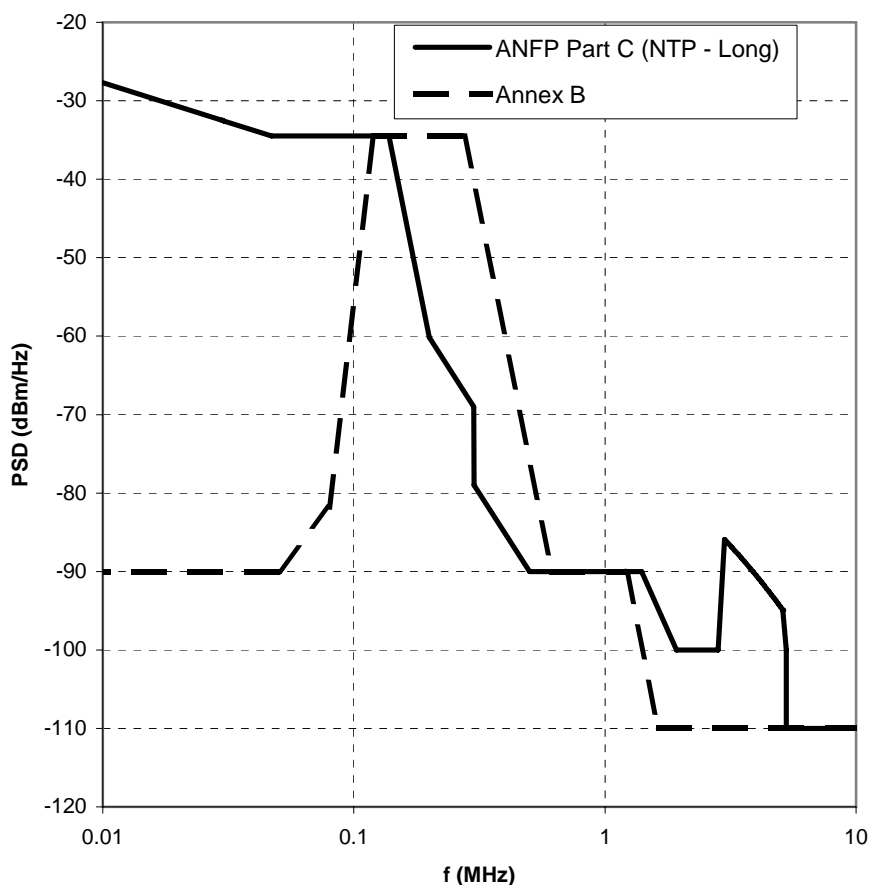
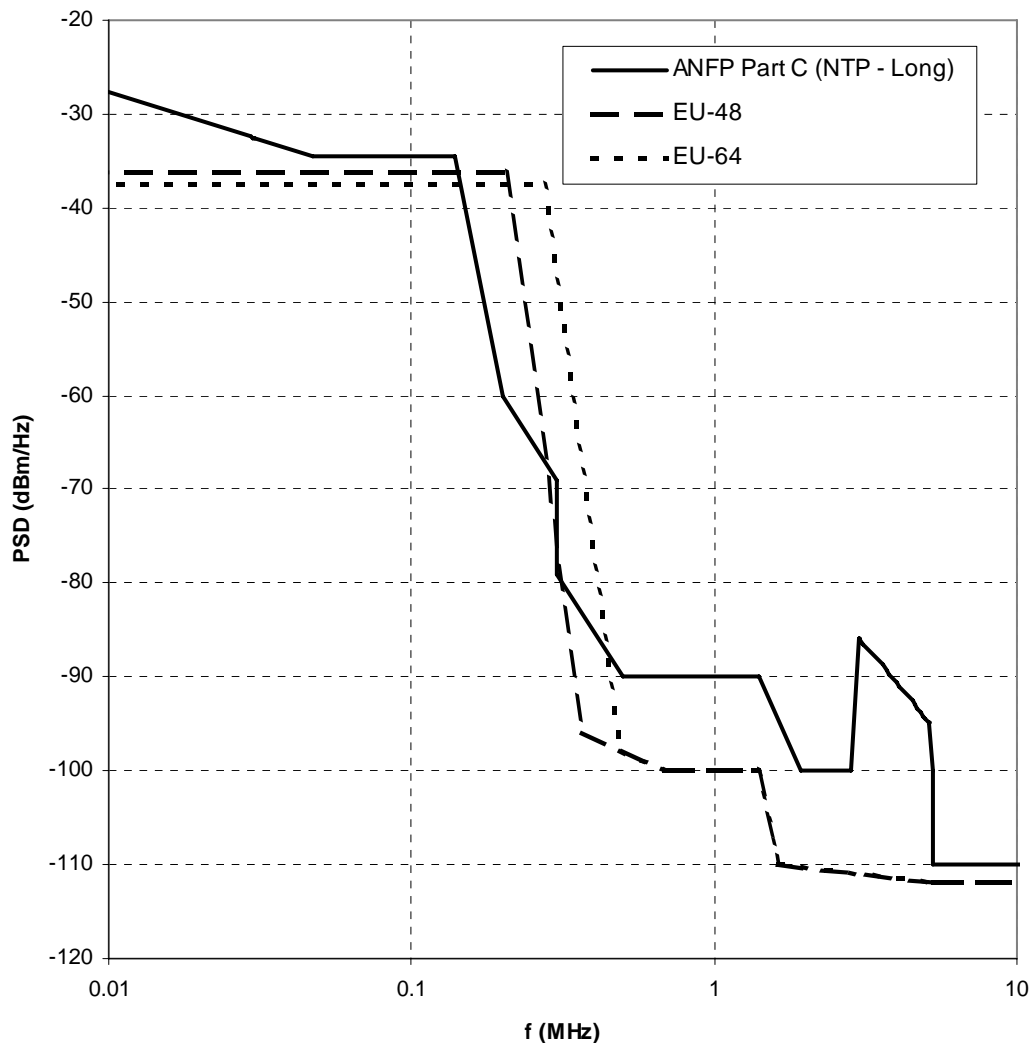

Figure 19 - ANFP Part C - long PSD mask using k10=0 and ADSL2 Annex B peak PSD.

**Annex J**

The ATU-R upstream transmit spectral mask for Annex J is not supported by the ANFP without upstream spectrum shaping.

Example shown in Figure 20. (The figure uses the values from ITU-T G.992.3 section J.2.2 “ATU R upstream transmit spectral mask”.)



**Figure 20 - ANFP Part C - long PSD mask using K10=0 and ADSL2 Annex J EU-48 and EU-64 peak PSD.**

PSD shaping can be used to modify the PSD EU-64 in Annex J of G.992.3 to be compliant to the requirements of the ANFP for short distances. Figure 21 shows the simulation results<sup>9</sup> on the impact on

<sup>9</sup> Nominal PSDs are used in the simulation (i.e., 3.5 dB less than max PSD)

Used downstream tones:	65-255;	Used upstream tones:	2-64
Coding gain:	5 dB;	SNR margin:	6 dB
SNRGAP:	9.75;	Used bits/tones:	1-15
Background noise:	-140 dBm/Hz;	Simulated test loop:	ETSI Loop # 1 (0.4 mm)

The simplified NEXT model was used. The FSAN summation method was used to combine different types of disturbers. The simulated scenario consisted of:

1. 49 ADSL Annex J as self-disturber
2. 24 Annex J + 24 SHDSL at 2.3 Mbit/s

performance as a result of the PSD shaping. From this it can be concluded that the performance loss between EU-64 and ANFP compliant EU-64 is not significant. Data rates of 2 Mbps are possible up to around 1.8 km with interference from 24 self-disturber + 24 SHDSL at 2.3 Mbps.

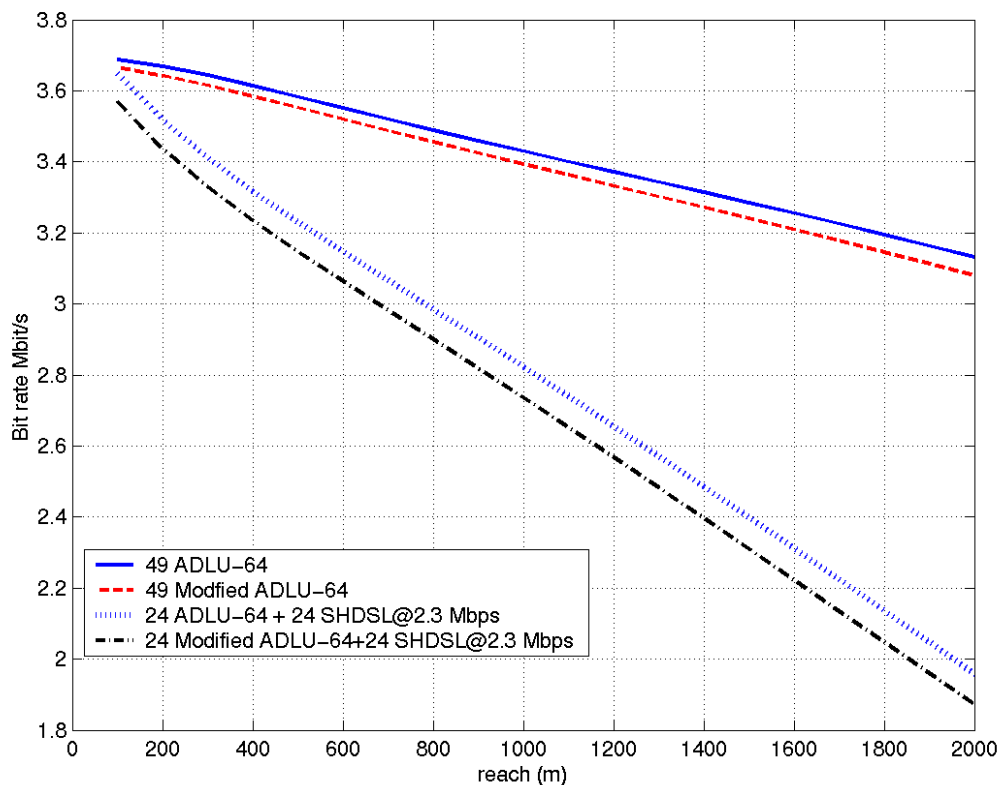

**Figure 21 - ADSL upstream bit rate with 49 self-disturbers and with 24 ADSL + 24 SHDSL at 2.3 Mbit/s.**

### **Annex L**

The ATU-R upstream transmit spectral mask for Annex L is not supported by the ANFP without upstream spectrum shaping.

Example shown in Figure 22. (The figure uses the values from ITU-T G.992.3 section L.2.2 “ATU-R upstream transmit spectral mask 1 for reach-extended operation” and section L.2.3 “ATU-R upstream transmit spectral mask 2 for reach-extended operation”).

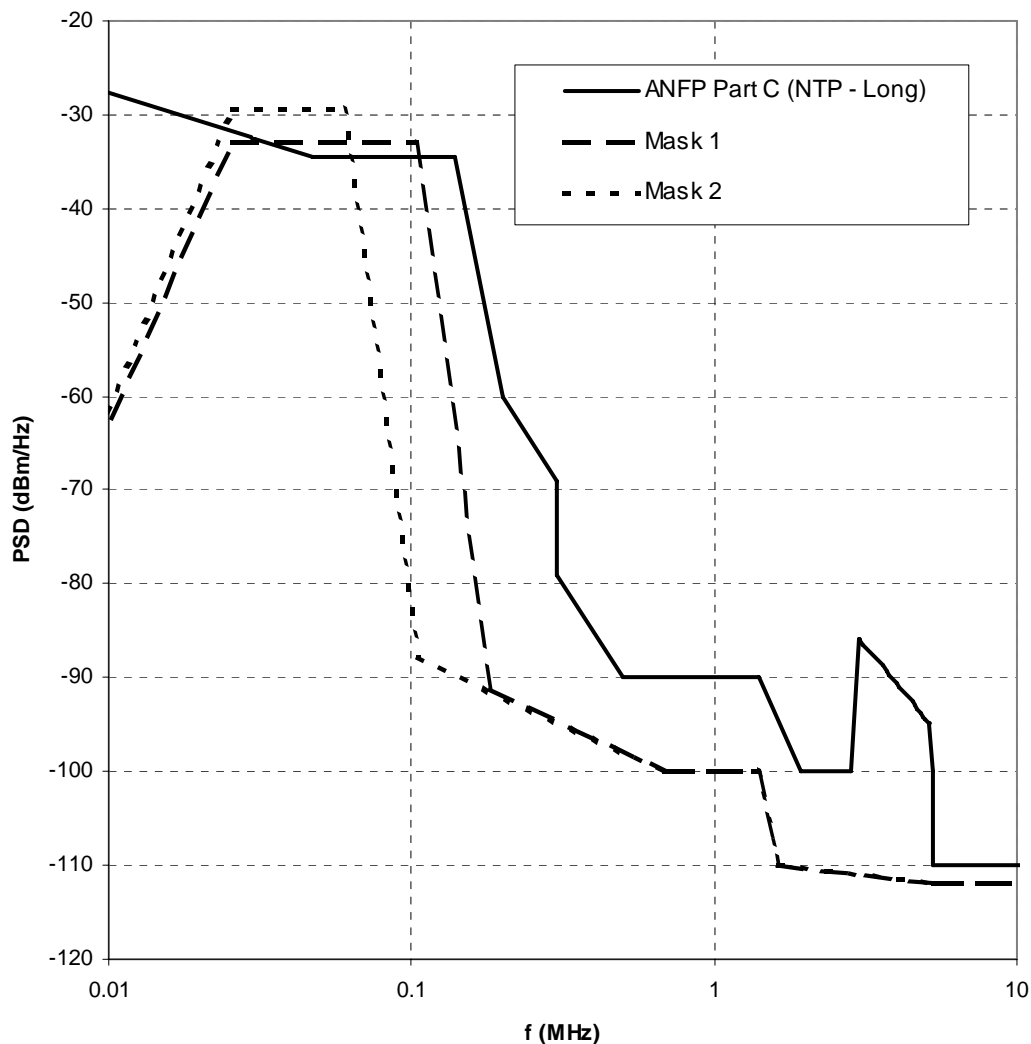
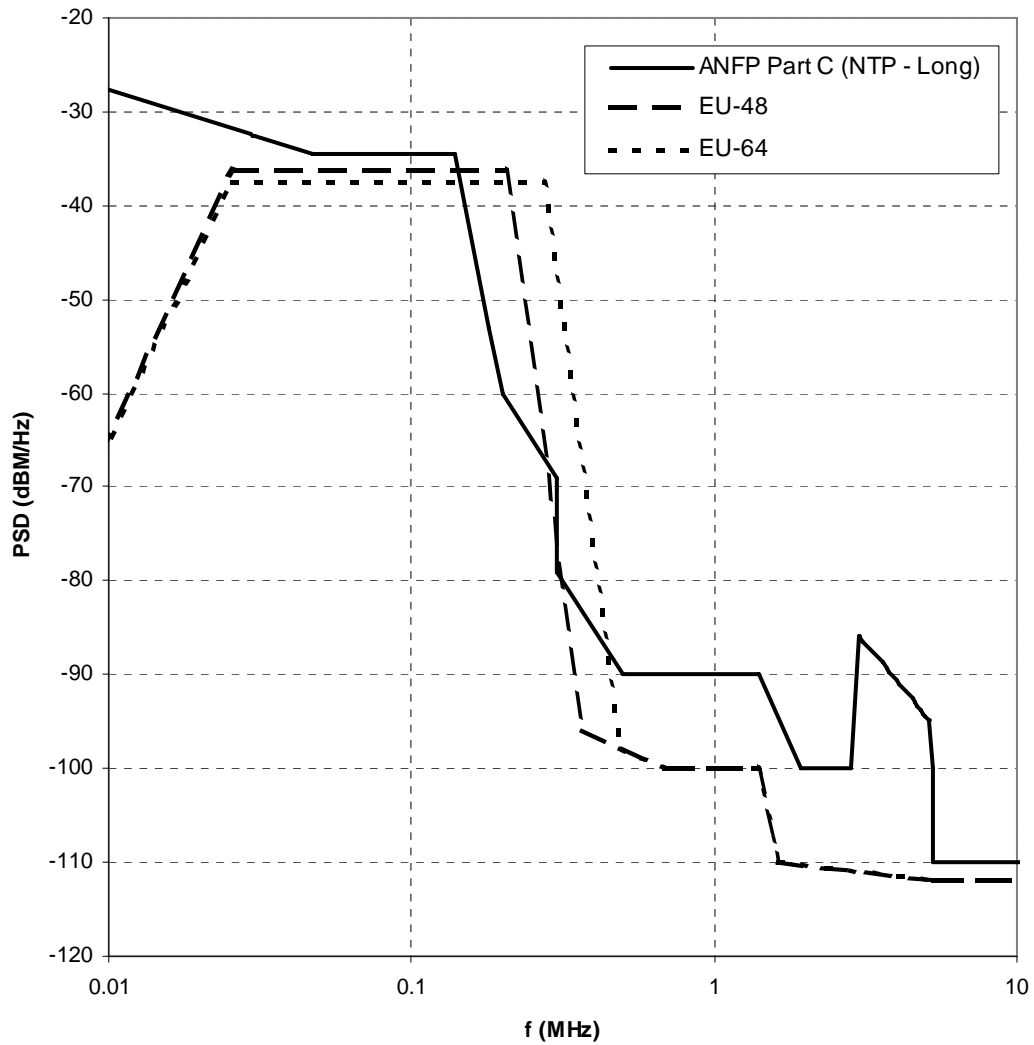

Figure 22 - ANFP Part C - long PSD mask using  $k_{10}=0$  and ADSL2 Annex L peak PSD.

**Annex M**

The ATU-R upstream transmit spectral mask for Annex M is not supported by the ANFP without upstream spectrum shaping - see also Section 6.8.

Example shown in Figure 23. (The figure uses the values from ITU-T G.992.3 and G.992.5 section M.2.2.1 “Passband PSD and response”)



**Figure 23 - ANFP Part C - short PSD mask using  $k_{l0}=0$  and ADSL2 Annex M EU-48 and EU-64 peak PSD mask.**



### 6.7 READSL2 (Annex L)

Annex L of the ITU ADSL standards, also known as READSL2 extends the reach of ADSL2 at low bit-rates through transmit PSD shaping. The upstream tones 6-14 can have a PSD boosted beyond the normal ADSL2 level of -38 dBm/Hz to a higher level of -32.9 dBm/Hz. Upstream tones 14-24 are boosted to -36.4 dBm/Hz. In the downstream direction, the PSD rises from the normal -40 dBm/Hz level at tone 32 to -37 dBm/Hz up to tone 128. Frequencies beyond tone 128 (552 kHz) are not used. This technique can extend the reach of ADSL or offer higher downstream rates on long lines. It is spectrally compatible with ADSL2 and being a derivative of the normal DMT ADSL standards it can be combined with ADSL and ADSL2 on the same line card. The standard facilitates auto-mode detection based on a handshake protocol that means that the DMT ADSL chips can automatically detect support of READSL2 to select the required operation mode. The down side of READSL2 is that the downstream max rate is limited to around 5.5 Mbit/s (and upstream rate limited to ~ 800 kbit/s).

*READSL2 is not supported by the ANFP - see section 6.6.1.1.*

### 6.8 Extended Upstream ADSL (Annex M)

Annex M of the ITU ADSL standards boosts the upstream data rate to around 3 Mbit/s. It achieves this shifting the split of frequencies between ADSL upstream and downstream bands to a higher frequency. This results in a larger upstream band at the expense of a narrower downstream band. Overall it uses a similar aggregate upstream power to ADSL2. Annex M can be combined with ADSL2 or ADSL2plus. Whilst ADSL Annex M can provide higher upstream rates for services such as high-quality videoconferencing, it is not spectrally compatible with ADSL over POTS (Annex A), which is widely deployed on the BT network. This is due to the crosstalk that would result in mutual interference because the Annex M upstream band overlaps with the Annex A downstream band (DMT tones 32-63).

*However, with spectrum shaping Annex M ADSL can be made to be compliant with the ANFP - see section 6.6.1.3 and also the Note in Section 6.*

### 6.9 ADSL2 Plus

ADSL2plus (also written as ADSL2+) reached consent at the ITU in January 2003, joining the ADSL2 standards family as G.992.5. The ADSL2plus recommendation doubles the downstream bandwidth, thereby increasing the downstream data rate on shorter telephone lines. While ADSL and ADSL2 standards specify a downstream frequency band up to 1.1 MHz, ADSL2+ specifies a downstream frequency up to 2.2 MHz (Figure 24). The result is a significant increase in downstream data rates on shorter phone lines. ADSL2+ upstream data rate is about 1 Mbps, depending on loop conditions.

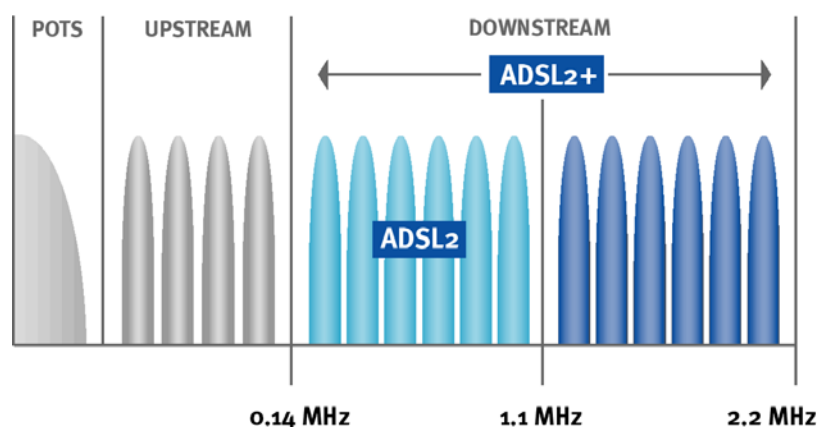

Figure 24 - ADSL2plus doubles the bandwidth used to carry downstream data

**6.9.1 ADSL2+ Compliance with ANFP**

Parts A, B, C and D given in the sub-section headings below, refer to the respective Part of the ANFP [1].

**6.9.1.1 Part A: MDF Requirements and Part D: MDF EO Requirements**

Table 9 is a summary of the compliance of ADSL2+ equipment with the ANFP Part A and Part D. All ADSL2+ tones are compliant (hence no tones are shown in *red* indicating non-compliance).

Annex	1-5	6-31	32-64	65-255	256-512
A	POTS		DOWN	DOWN	DOWN
B	ISDN	ISDN		DOWN	DOWN
C	TCM ISDN		DOWN	DOWN	DOWN
I			DOWN	DOWN	DOWN
J				DOWN	DOWN
L	N/A	N/A	N/A	N/A	N/A
M	POTS			DOWN	DOWN

**Table 9 - ADSL2+ v ANFP Part A and Part D**

**6.9.1.2 Part B: Cabinet Requirements**

Table 10 is a summary of the compliance of ADSL2+ equipment with the ANFP Part B, where tones shown in *red* indicate non-compliance.

Annex	1-5	6-31	32-64	65-255	256-512
A	POTS		<i>DOWN</i>	<i>DOWN</i>	<i>DOWN</i>
B	ISDN	ISDN		<i>DOWN</i>	<i>DOWN</i>
C	TCM ISDN		<i>DOWN</i>	<i>DOWN</i>	<i>DOWN</i>
I			<i>DOWN</i>	<i>DOWN</i>	<i>DOWN</i>
J				<i>DOWN</i>	<i>DOWN</i>
L	N/A	N/A	N/A	N/A	N/A
M	POTS			<i>DOWN</i>	<i>DOWN</i>

**Table 10 - ADSL2 v ANFP Part B**

The cases where tones used are not supported by ANFP are demonstrated in Figure 25 below.

The ATU-C downstream transmit spectral mask for all Annex (A, B, I, J, and M) is not supported by the ANFP without downstream spectrum shaping. See Figure 25. (The figure uses the values from ITU-T G.992.5 section A.1.3 "ATU-C transmitter PSD mask for non-overlapped spectrum operation".)

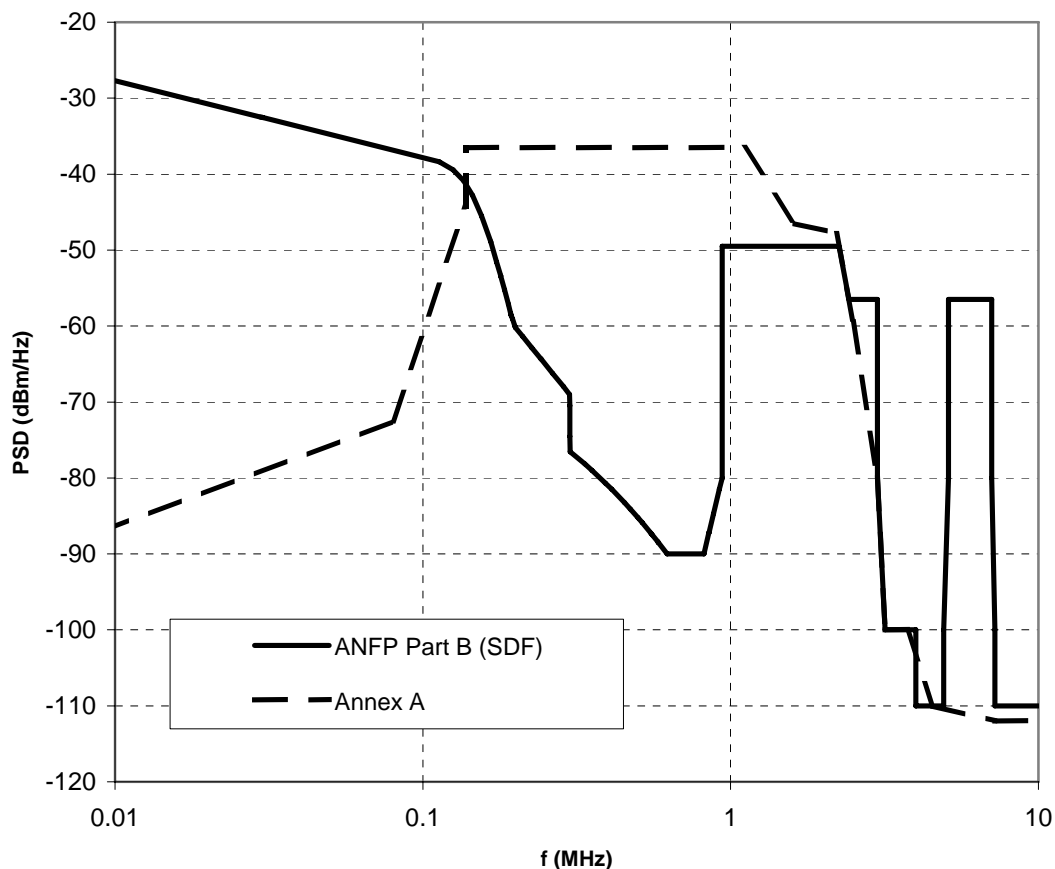

**Figure 25 - ANFP Part B PSD mask with CAL = 40 and ADSL2+ Annex A downstream peak PSD mask.**

**6.9.1.3 Part C: Customer End Requirements**

Table 11 is a summary of the compliance of ADSL2+ equipment with the ANFP Part C, where tones shown in **red** indicate non-compliance.

Annex	1-5	6-31	32-64	65-255	256-512
A	POTS	UP			
B	ISDN	ISDN	<b>UP</b>		
C	TCM ISDN	UP			
I	UP	UP			
J	UP	UP	<b>UP</b>		
L	N/A	N/A	N/A	N/A	N/A
M	POTS	UP	<b>UP</b>		

**Table 11 - ADSL2+ v ANFP Part C**

For examples see section 6.6 "ADSL and ADSL2".

### 6.10 VDSL

Very high speed Digital Subscriber Line, or VDSL (G.993.1), can operate in either a symmetric or an asymmetric mode and provides up to 52 Mbps of total data capacity over voice on a single twisted-pair copper loop. The VDSL specification approved by the ITU in 2004 is based on the T1E1 T1.424-2004 specification and the ETSI specifications TS 101 270-1 V1.3.1 (2003-07) and TS 101 270-2 V1.2.1 (2003-07), which provide the European requirements, and transceiver specification. VDSL is twice as fast as ADSL2plus and nearly ten times faster than ADSL. The trade-off for increased speed is loop length: VDSL has a shorter reach in the loop.

Like other DSL technologies, VDSL uses the higher-frequency spectrum available over standard copper above the frequencies used for lifeline POTS and ISDN services. This is commonly referred to as data- and video-over-voice technology. This technology enables telecommunication operators to utilize existing copper infrastructure for the delivery of broadband services over the same physical plant. The VDSL spectrum is specified to range from 200 kHz to 12 MHz. Actual spectral allocation varies based on line rates and whether or not asymmetric or symmetric rates are being used. The baseband for lifeline POTS and ISDN service is preserved by using passive filters commonly known as splitters.

There is one main band plan plus one alternate band plan that define what frequencies shall be used for upstream and downstream transmission as shown in Figure 26 below.

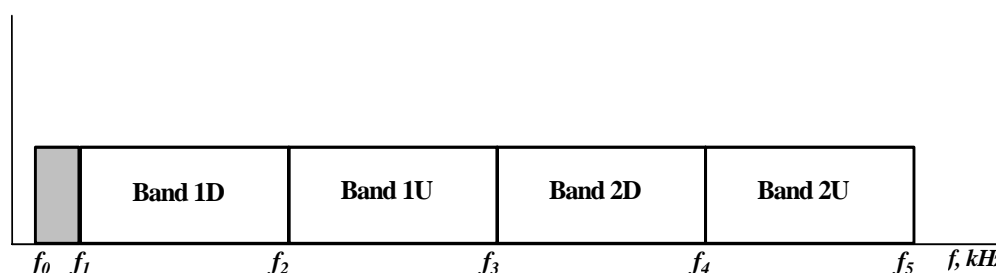

Figure 26 - Illustrative VDSL Band Allocation

Band Transition Frequencies (kHz)	$f_0$	$f_1$	$f_2$	$f_3$	$f_4$	$f_5$
VDSL bands	25	138	3 000	5 100	7 050	12 000
Optional regional-specific bands	25	138	3 750	5 200	8 500	12 000

Table 12: Band transition frequencies

NOTE 1: Use of frequencies above  $f_5$  is not defined.

NOTE 2: Use of frequencies between  $f_0$  and  $f_1$  in the upstream direction is optional.

NOTE 3: The VDSL bands correspond to the frequency plan formerly named 997 and the optional regional-specific bands correspond to the frequency plan formerly named 998.

The band allocation for VDSL is shown in Figure 27.

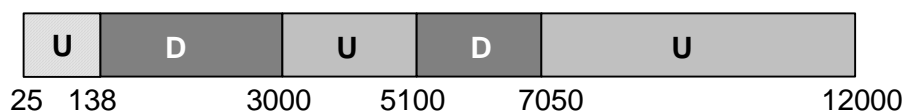
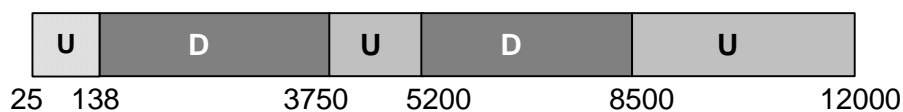

Figure 27 - VDSL Band Allocation

Optionally, modems may use the band allocation shown in Figure 28 to satisfy alternative regional requirements.



**Figure 28 - Optional regional-specific VDSL Band Allocation**

There are many different deployment scenarios discussed in the standards and each one has a unique PSD mask. The compatibility of systems compliant with these mask is discussed in the next section. Note that on longer loops no useful capacity is available in the bands D2 and U2 so the modem may choose not to transmit any energy in them.

The modem at the customer premises must implement an Upstream Power Back Off (UPBO) algorithm which is used to reduce the transmit power on short loops. The modem estimates the loop attenuation (electrical length) and derives the parameter  $kl_0$  which is used to define the upper limit for the transmit PSD.

The general form of the equation to calculate the PSD at any in-band frequency is:-

$$TxPSD(kl_0, f) = -a - b\sqrt{f} + kl_0\sqrt{f} \quad \text{in dB}$$

Where the constants appropriate for use with the ANFP are  $a = 60$  and  $b = 17$ . Note that  $kl_0$  is limited to the range 0 to 17.

The network operator can also use its management system to impose a maximum up-stream PSD limit on the modem.

Deployment of VDSL is more suitable for short line lengths (preferably less than 1 km):

#### **6.10.1 VDSL Compliance with ANFP**

The ANFP prohibits the use of VDSL from the exchange, even on short line lengths that have no sub-loops.

VDSL cannot normally comply with the ANFP Part B requirement to shape the downstream PSD for transmissions from cabinets, and so cannot normally be considered compliant with the ANFP. However where the cabinet CAL value equals or exceeds approximately 36, there is access to unshaped spectrum above 1.104 MHz. There are optional bandplans for VDSL which could be deployed at such cabinets, however VDSL technology should be considered as obsolescent and for new deployments VDSL2 (see section 6.11) is much preferable in the UK.

#### **6.11 VDSL2**

The ITU standard for VDSL2 has now been approved as G.993.2 (02/2006), for speeds up to 200 Mbits/s using bandwidths up to 30MHz. There are a variety of profiles/band plans intended for different national and technological applications. The profile compatible with ANFP compliance is Annex B (997) Profile 8c, enabling bit rates up to 50Mbit/s using frequencies up to 7.05MHz. No other profiles or Annexes are likely to be compatible with the ANFP.

The PSD shaping required to meet the requirements of Part B of the ANFP is supported through the definition of appropriate “MIB PSD Masks” which are described in section 7.2.1.1 of the standard.

The standard for the MIB itself that is used to set up appropriate MIB PSD masks is described in ITU-T Rec. G.997.1. (06/2006). The managed object is known as Downstream Power Back-Off – Shaped (DPBOSHAPED) and is described in section 7.3.1.2.13.

Nine parameters (DPBOEPSD, DPBOESCMA, DPBOESCMB, DPBOESCMC, DPBOMUS, DPBOFMIN, DPBOFMAX, DPBOLFO, DPBOMUS) need to be set up in the MIB to configure it correctly. Once this is done any value of CAL for ANFP use can be selected by choosing an appropriate value for another MIB parameter, DPBOESEL. System vendors should be able to assist in setting these parameters correctly so that particular ANFP Part B masks are complied with.

### 6.12 Ethernet in First Mile

Ethernet in the First Mile (EFM) is a technology using DSL technology as its linecode. It is specified in IEEE Standard 802.3ah - 2004. A description of EFM is given in [5]. At the physical layer, EFM uses either enhanced SHDSL or VDSL for transmission over the metallic access network and hence its compliance with the ANFP is the same as the compliance of enhanced SHDSL and VDSL. See Sections 6.5 for enhanced SHDSL compliance and Sections 6.10 and 6.11 for VDSL compliance.

## 7. Abbreviations

ADSL	Asymmetric Digital Subscriber Line
ANFP	Access Network Frequency Plan
BT	British Telecommunications plc
CAL	Cabinet Assigned Loss
CPE	Customer Premises Equipment
DSL	Digital Subscriber Line - any of the modem technologies that send high-speed data over metallic telephone pairs. A DSL line has a dedicated modem at each end of the physical wire pair; typically one of these is in the exchange
DSLAM	Digital Subscriber Line Access Multiplexer
EFM	Ethernet in the First Mile
EFMA	Ethernet in the First Mile Alliance (see <a href="http://www.efmalliance.org">http://www.efmalliance.org</a> )
ETSI	European Telecommunications Standards Institute
HDSL	High bit rate Digital Subscriber Line
ITU-T	International Telecommunication Union - Telecom Standardization
KCH	Kingston Communications (Hull) plc
LLU	Local Loop Unbundling
LLUO	Local Loop Unbundling Operators
MDF	Main Distribution Frame
NICC	Network Interoperability Consultative Committee - a committee of UK industry set up to advise Ofcom (and previously, Oftel) homepage: <a href="http://www.nicc.org.uk">http://www.nicc.org.uk</a>
NTP	Network Termination Point
POTS	Plain Ordinary Telephone Service - analogue voiceband telephony
PSD	Power Spectral Density
SDF	Sub-loop Distribution Frame – the equipment block which terminates the sub-loop access network cables. This is inside a SLCP.

SDSL	Symmetric single pair high bitrate Digital Subscriber Line A term used in ETSI to refer to SHDSL. This should not be confused with the USA use of the term 'SDSL' which refers to DSL systems similar to HDSL.
SHDSL	Single-pair High-speed Digital Subscriber Line
SLCP	Sub Loop Connection Point – the flexibility point in BT’s network at which the network is opened for access to the subloop. Colloquially the term ‘cabinet’ has been used.
UPBO	Upstream Power Back-Off – power control applied at the customer end modems so that crosstalk from short lines does not disable use of long lines.
xDSL	any variant of DSL modem e.g. ADSL, HDSL, SHDSL or VDSL
VDSL	Very high speed Digital Subscriber Line

## 8. References

- [1] Specification of the Access Network Frequency Plan applicable to transmission systems used on the BT Access Network Issue 4 – ND1602:2007/03 (*available on NICC website at <http://www.nicc.org.uk/nicc-public/Public/interconnectstandards/isc.htm>*)
- [2] Specification of the Access Network Frequency Plan applicable to transmission systems used on the BT Access Network Issue 3 – ND1602:2005/08 (*available on NICC website at <http://www.nicc.org.uk/nicc-public/Public/interconnectstandards/isc.htm>*)
- [3] Specification of the Access Network Frequency Plan applicable to transmission systems used on the KCH Access Network – ND1604:2003/01 (*available on NICC website at <http://www.nicc.org.uk/nicc-public/Public/interconnectstandards/isc.htm>*)
- [4] DSL Forum Marketing Report MR-001; DSL Anywhere - Issue 2, September 2004. Available at [http://www.dslforum.org/aboutdsl/whitepaper\\_index.html](http://www.dslforum.org/aboutdsl/whitepaper_index.html)
- [5] Ethernet in the First Mile Alliance - White Paper  
Available at [http://www.efmalliance.org/whitepapers/EFMA\\_WP\\_2003.pdf](http://www.efmalliance.org/whitepapers/EFMA_WP_2003.pdf)
- [6] Report on the Mutual Compatibility of Transmission Systems used in Public Access & Private Networks - ND1506:2004/11 (*available on NICC website at <http://www.nicc.org.uk/nicc-public/Public/interconnectstandards/isc.htm>*)

## 9. History

Issue No.	Date	Comments
1	August 2005	First Issue
2	March 2007	Updated to take account of updating of BT ANFP to Issue 4

- END -